

# Smart ZYNQ SL VER: 1.3/1.3B Block Diagram

此原理图同样适用于v1.0 v1.1 v1.2版本硬件电路  
This schematic is also applicable to the V1.0, V1.1 V1.1and V1.2 version hardware circuits.

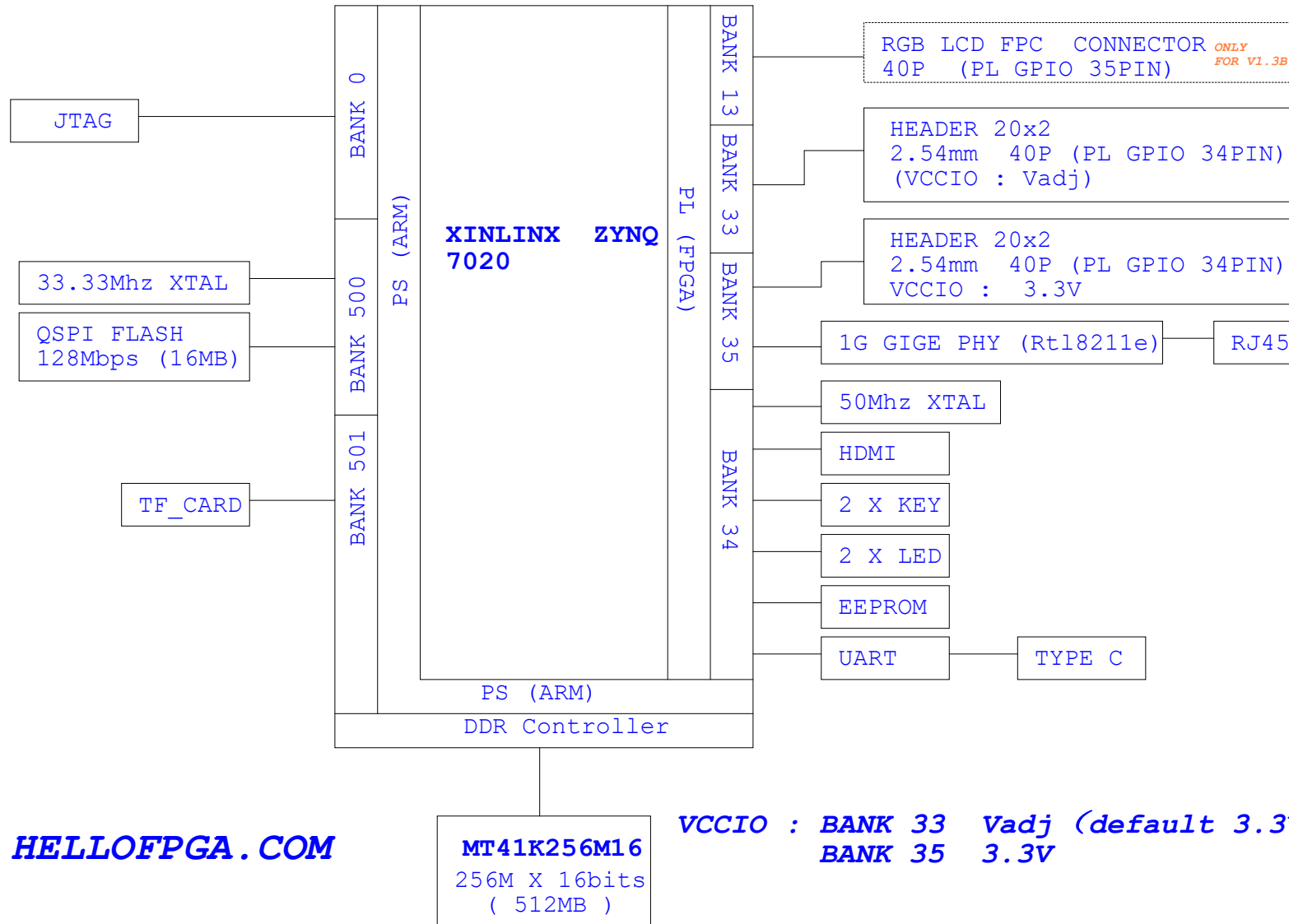

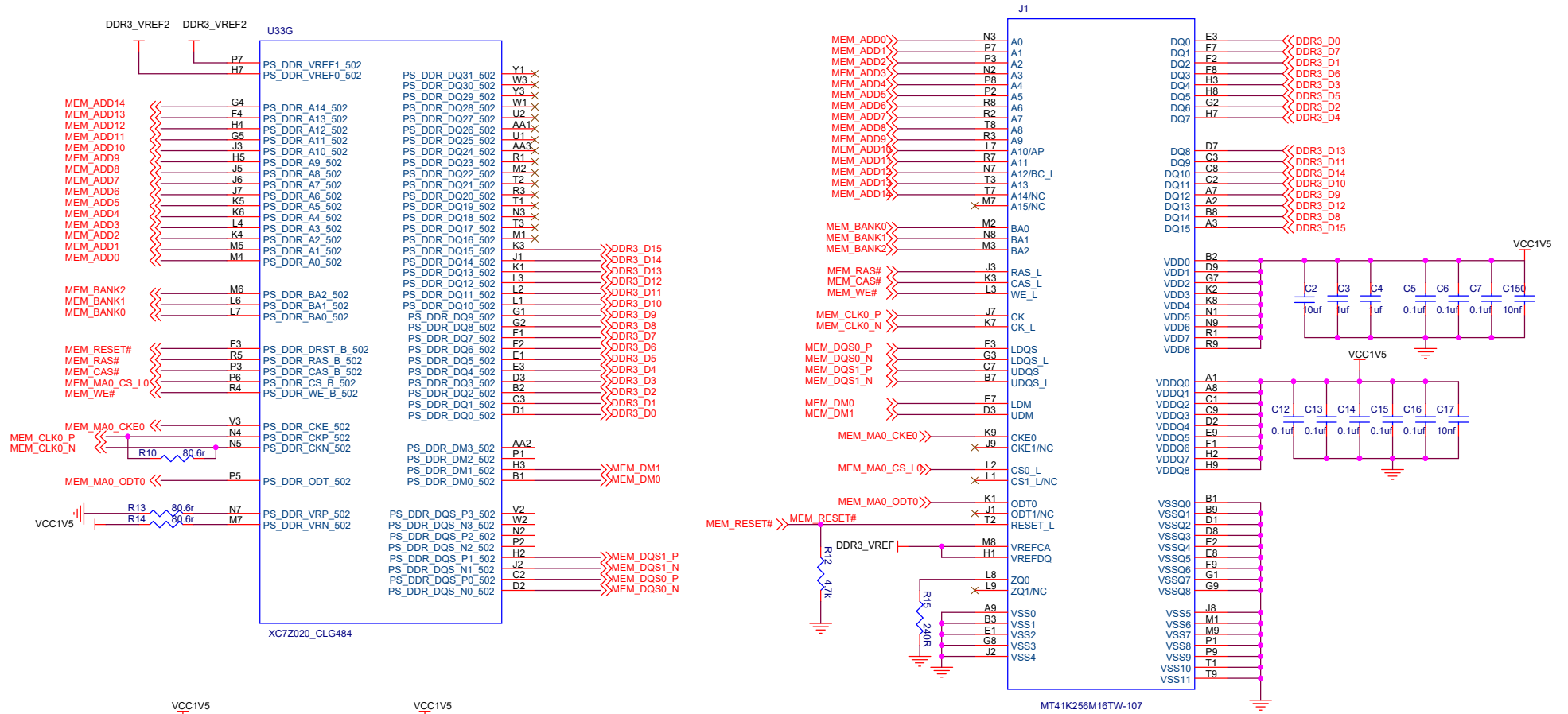



# DDR PART

HELLOFPGA.COM

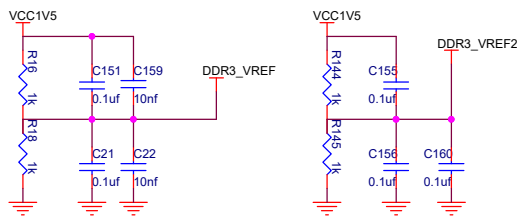

Title		
HELLOFPGA.COM		
Size	Document Number	Rev
B	<Doc>	<1.3B>
Date:	Monday, April 13, 2026	Sheet 1 of 1

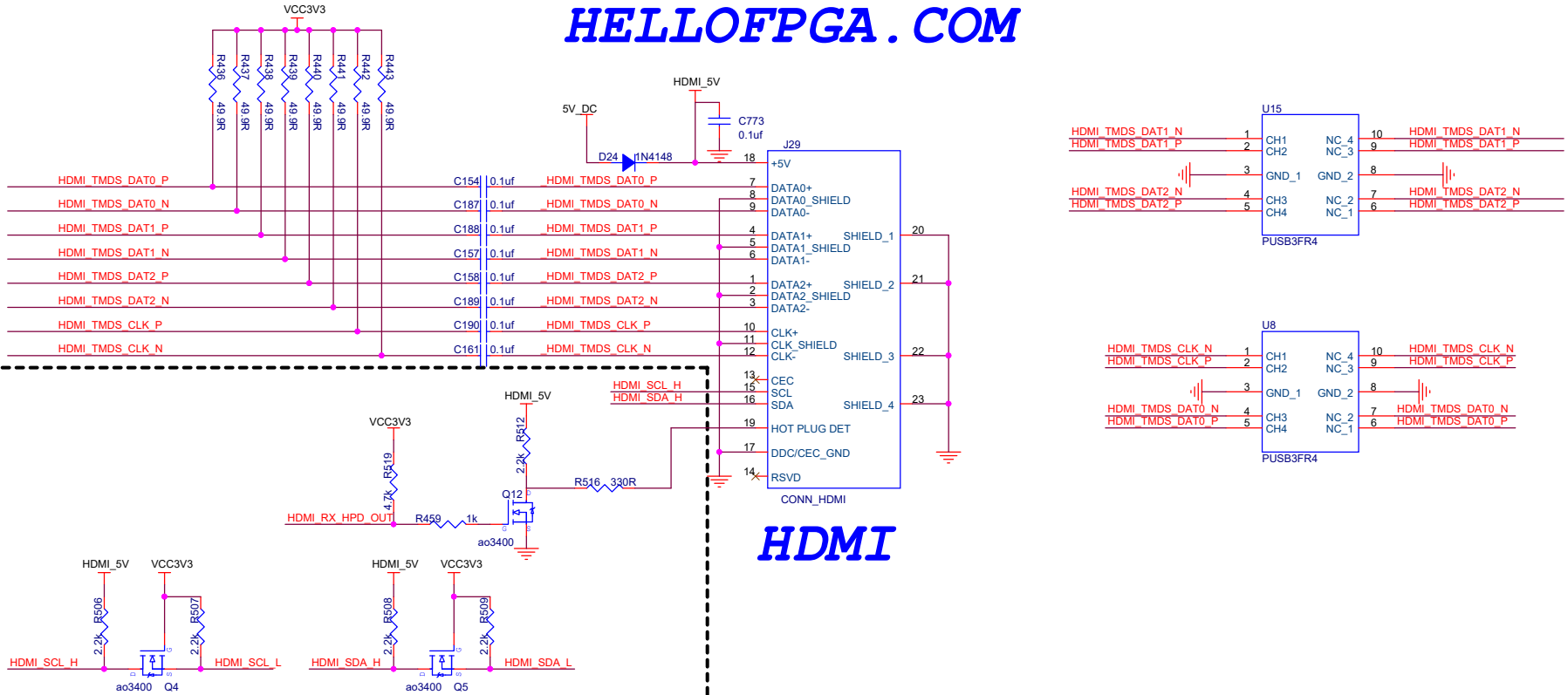

## HDMI

注意：v1.3/v1.3B版本硬件中新增HDMI SDA, HDMI\_SCL, RX\_HPDI\_OUT 三个信号（v1.2之前版本中不存在）

Note: The circuit version 1.3/1.3B introduces three new HDMI signals SDA, SCL, and RX\_HPDI\_OUT which are not present in circuit versions 1.2, 1.1, and 1.0.

版本信息标注在主板的丝印上

Please check the version information indicated on the silk-screen markings of the motherboard

Title		
HELLOFPGA.COM		
Size	Document Number	Rev
B	<Doc>	<1.3B>
Date:	Monday, April 13, 2026	Sheet 1 of 1

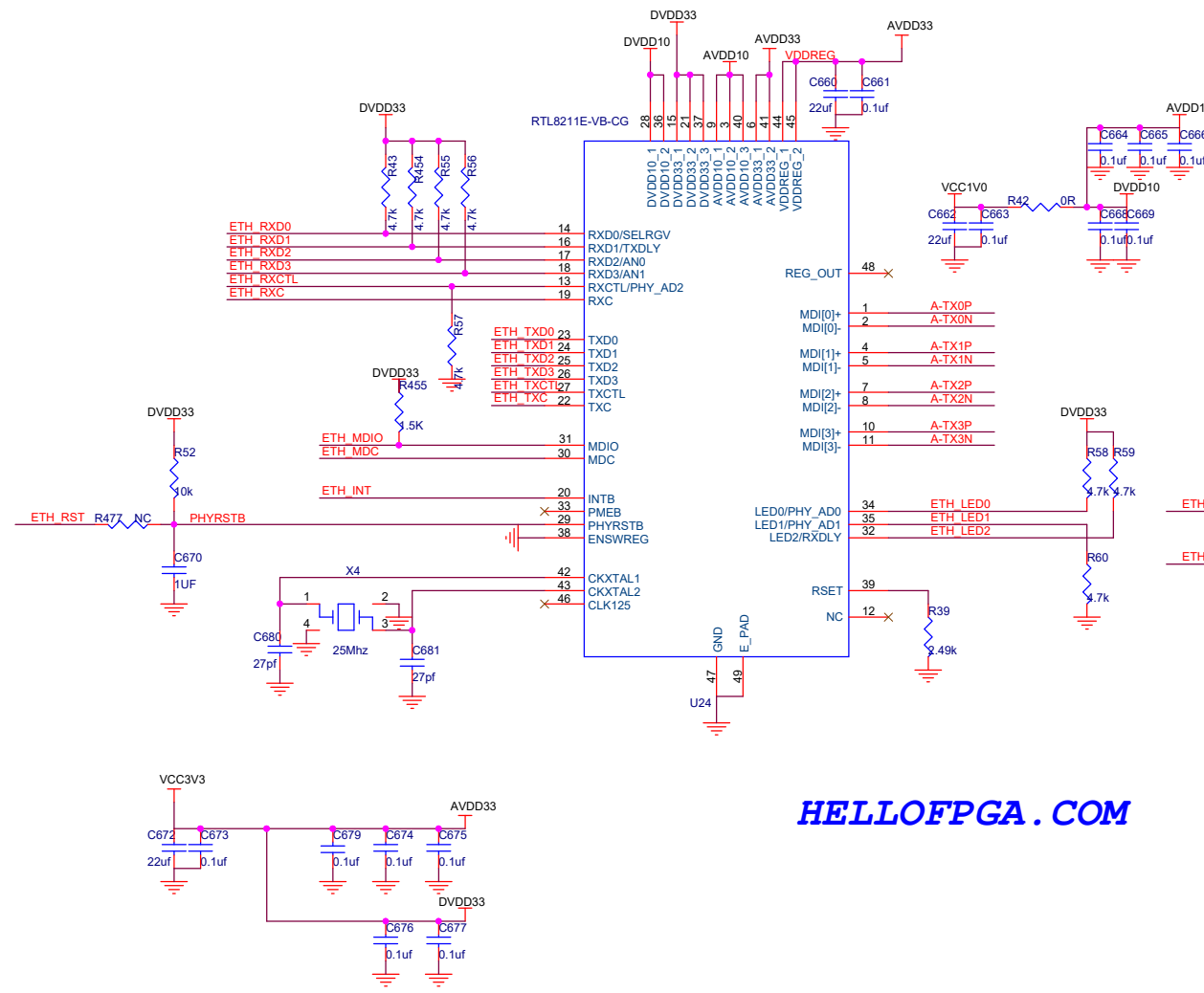

# NET PART

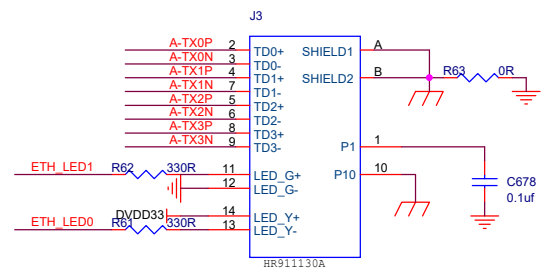

HELLOFPGA.COM

Title		
HELLOFPGA.COM		
Size	Document Number	Rev
B	<Doc>	<1.3B>
Date:	Monday, April 13, 2026	Sheet 1 of 1

# QSPI FLASH

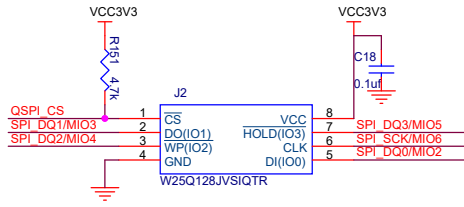

# EEPROM

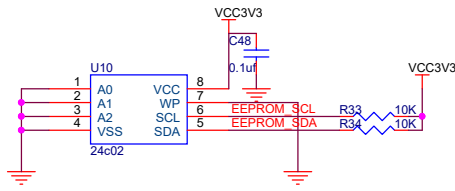

# PL CLK

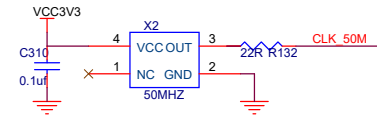

# TF CARD

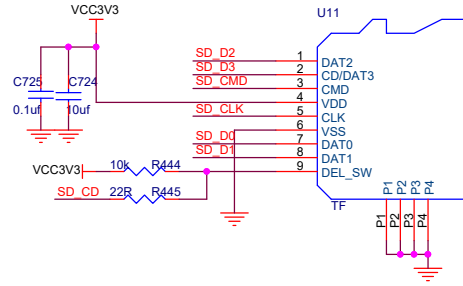

# PS CLK

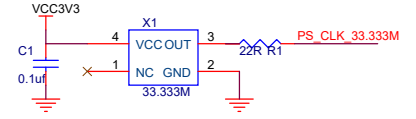

# KEY

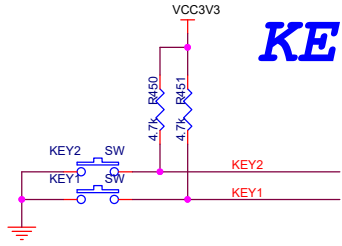

# BOOT

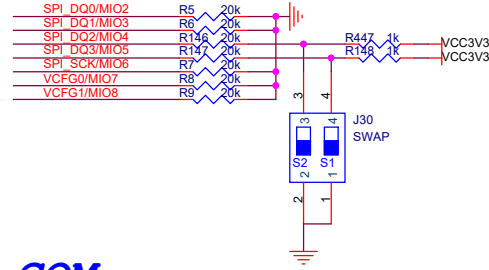

# LED

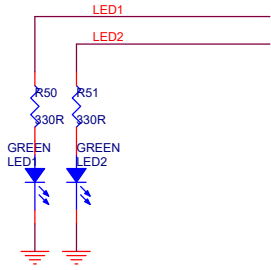

# BOOT

BOOT	S1	S2
JTAG	●	●
QSPI	○	●
SD	○	○

HELLOFPGA.COM

Title		
HELLOFPGA.COM		
Size	Document Number	Rev
B	<Doc>	<1.3B>
Date:	Monday, April 13, 2026	Sheet 1 of 1

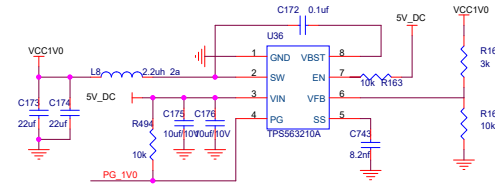
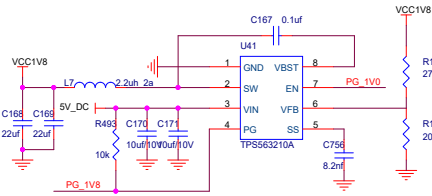
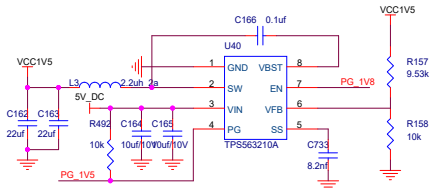

## POWER

## VADJ

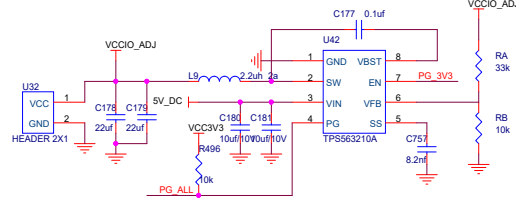
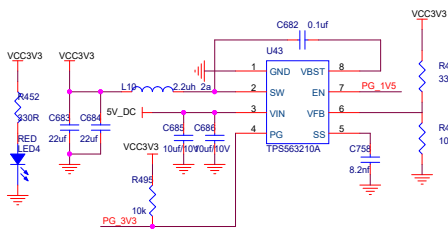

Default Vadj = 3.3V

VADJ	RA	RB
3.3V	33K	10K
2.5V	22.6K	10K
1.8V	13.7K	10K

Default Vadj = 3.3V

## HELLOFPGA.COM

## TYPE C & UART

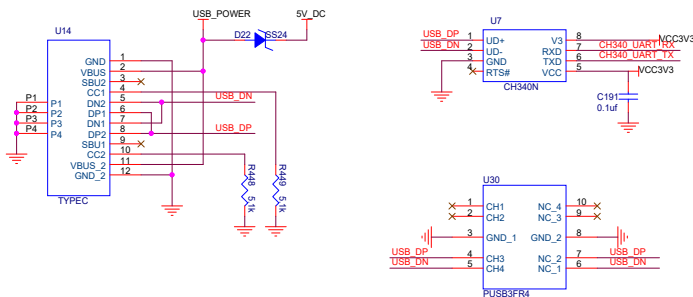

## JTAG

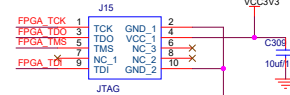

## RGB LCD

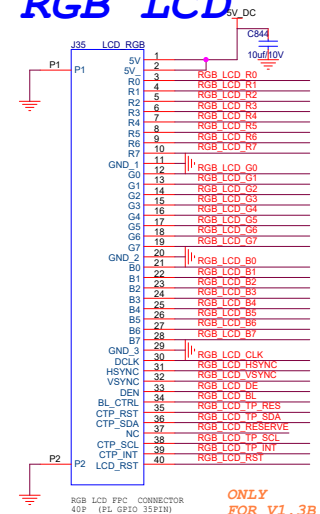

ONLY FOR V1.3B

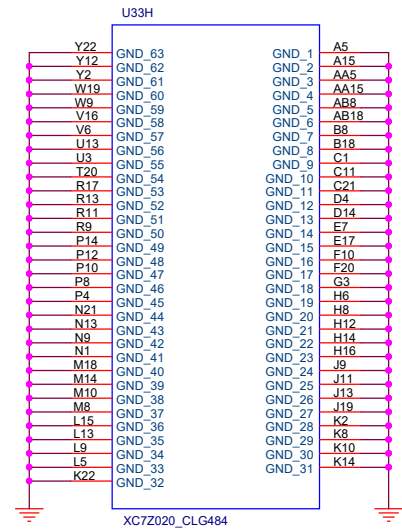
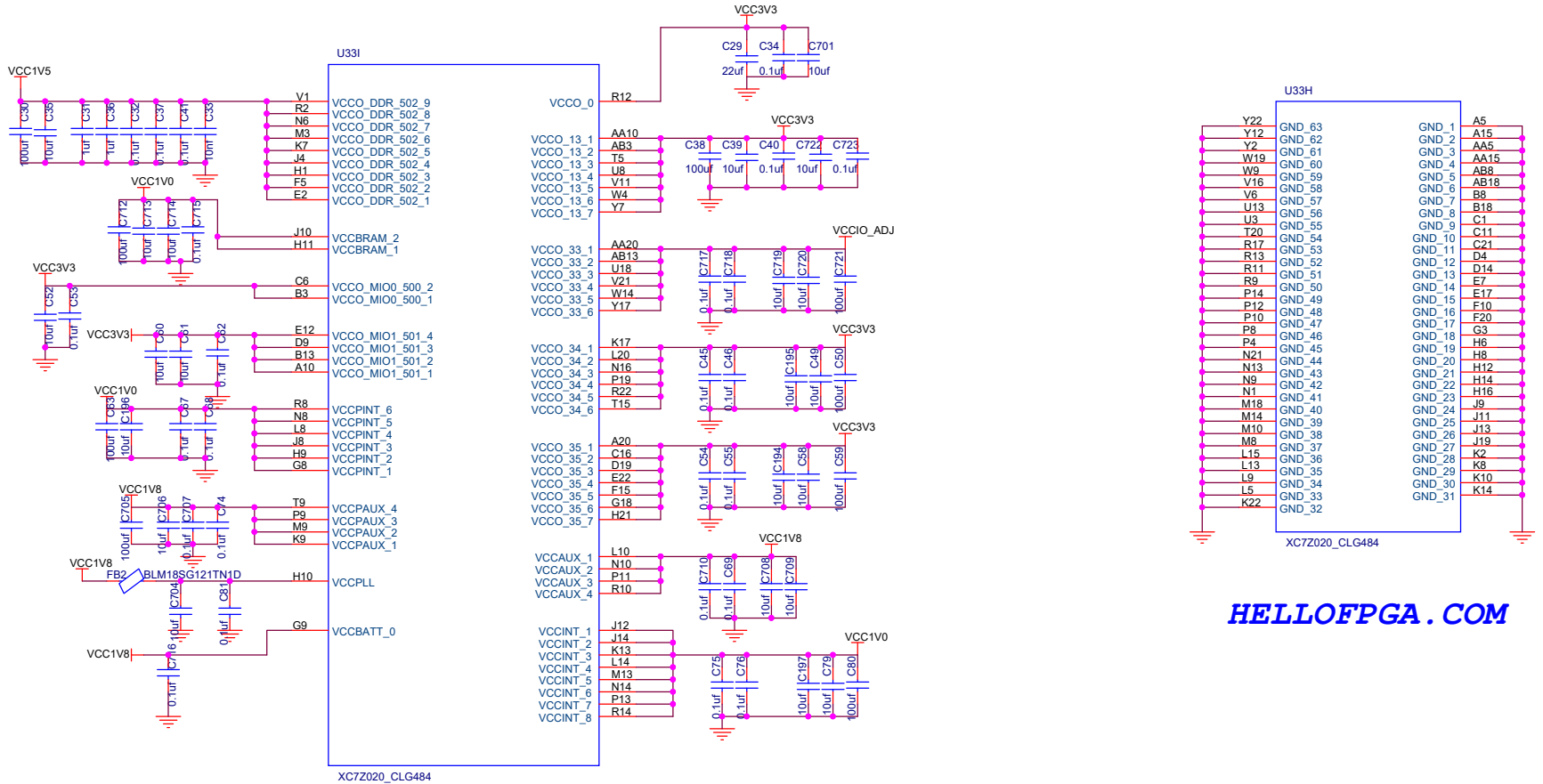

HELLOFPGA.COM

Title		
HELLOFPGA.COM		
Size	Document Number	Rev
B	<Doc>	<1.3B>
Date:	Monday, April 13, 2026	Sheet 1 of 1

VER:1.2/1.3/1.3B

J5 BANK 35

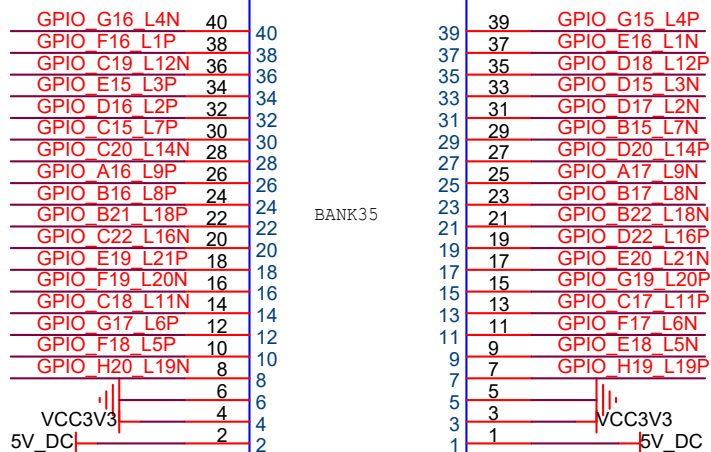

HEADER 20x2

VCCIO : 3.3V

VER 1.1 / 1.0

J5 BANK 35

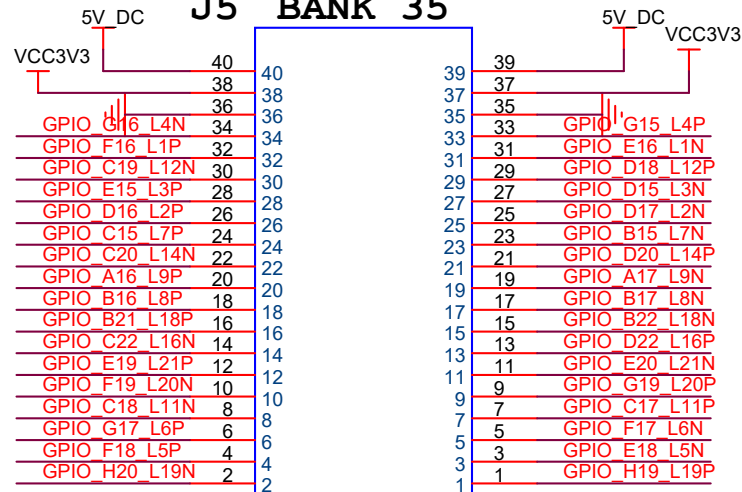

HEADER 20x2

VCCIO : 3.3V

J6 BANK 33

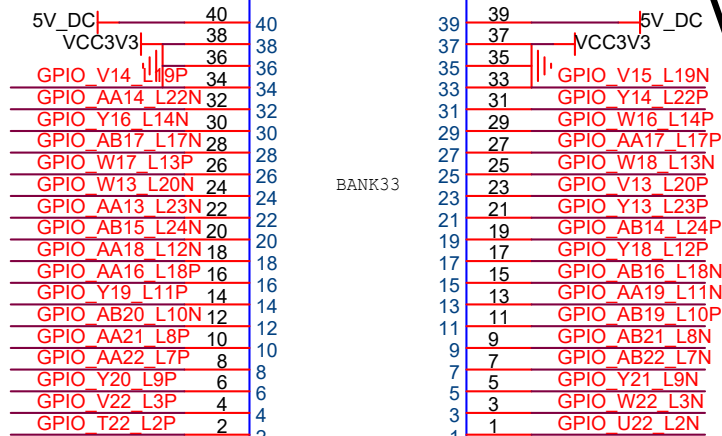

HEADER 20x2

VCCIO : VADJ  
Default Vadj = 3.3V

请注意: V1.2 V1.3 V1.3B 版本的主板J5排针部分和v1.1/v1.0版本并不兼容

Please note: Version 1.2/1.3/1.3B J5 pinout is not compatible with versions 1.1/1.0.

版本信息标注在主板的丝印上

Please check the version information indicated on the silk-screen markings of the motherboard

HELLOFPGA.COM

Title		
HELLOFPGA.COM		
Size	Document Number	Rev
A	<Doc>	<1.3B>
Date:	Tuesday, April 14, 2026	Sheet 1 of 1

## 50M CLOCK

CLK	M19
-----	-----

## KEY & LED

KEY1	K21
------	-----

KEY2	J20
------	-----

LED1	P20
------	-----

LED2	P21
------	-----

## UART

ZYNQ_TX	L17
---------	-----

ZYNQ_RX	M17
---------	-----

## HDMI

V1.0/V1.1/V1.2 V1.3/V1.3B

CLK	N22	N19
-----	-----	-----

D0	M21	M21
----	-----	-----

D1	L21	L21
----	-----	-----

D2	J21	J21
----	-----	-----

SDA	/	K20
-----	---	-----

SCL	/	K19
-----	---	-----

RX_HPD_OUT	/	L19
------------	---	-----

## EEPROM

SCL	R20
-----	-----

SDA	R21
-----	-----

## GigE phy

ETH TD0	E21
---------	-----

ETH TD1	F21
---------	-----

ETH TD2	F22
---------	-----

ETH TD3	G20
---------	-----

ETH TX_CTL	G22
------------	-----

ETH TXC	D21
---------	-----

ETH RD0	A22
---------	-----

ETH RD1	A18
---------	-----

ETH RD2	A19
---------	-----

ETH RD3	B20
---------	-----

ETH RX_CTL	A21
------------	-----

ETH RXC	B19
---------	-----

ETH MDIO	H22
----------	-----

ETH MDC	G21
---------	-----

ETH INT	H18
---------	-----

## RGB\_LCD

R7	Y4
----	----

R6	V10
----	-----

R5	AB12
----	------

R4	U10
----	-----

R3	AA8
----	-----

R2	AB7
----	-----

R1	AA12
----	------

R0	V7
----	----

G7	AB10
----	------

G6	AA9
----	-----

G5	Y9
----	----

G4	W8
----	----

G3	Y8
----	----

G2	Y6
----	----

G1	V8
----	----

G0	AB9
----	-----

B7	W6
----	----

B6	AB5
----	-----

B5	AB4
----	-----

B4	AB6
----	-----

B3	W7
----	----

B2	AA7
----	-----

B1	V4
----	----

B0	Y5
----	----

HSYNC	V9
-------	----

VSYNC	AB2
-------	-----

CLK	AA4
-----	-----

DE	AA6
----	-----

BL	U7
----	----

RST (RESERVE)	W5
---------------	----

TP_RES	U6
--------	----

TP_INT	U4
--------	----

TP_SCL	U5
--------	----

TP_SDA	AB1
--------	-----

## TOUCH

(RESERVE)	V5
-----------	----

HELLOFPGA.COM

# Smart ZYNQ SL board Pin Constraint Definition Reference

```

## J5 on board (BANK35 V3V3)
# Set voltage level for banks 35 (match with jumper setting on board)
set_property IOSTANDARD LVCMOS33 [get_ports {J5[*]}]
set_property PACKAGE_PIN H19 [get_ports {J5[0]}] #IO B35 LP19
set_property PACKAGE_PIN H20 [get_ports {J5[1]}] #IO B35 LN19
set_property PACKAGE_PIN E18 [get_ports {J5[2]}] #IO B35 LNS
set_property PACKAGE_PIN E19 [get_ports {J5[3]}] #IO B35 LNS
set_property PACKAGE_PIN F17 [get_ports {J5[4]}] #IO B35 LNS
set_property PACKAGE_PIN G17 [get_ports {J5[5]}] #IO B35 LP6
set_property PACKAGE_PIN C17 [get_ports {J5[6]}] #IO B35 LP11
set_property PACKAGE_PIN C18 [get_ports {J5[7]}] #IO B35 LN11
set_property PACKAGE_PIN G19 [get_ports {J5[8]}] #IO B35 LP20
set_property PACKAGE_PIN F19 [get_ports {J5[9]}] #JIO B35 LN20
set_property PACKAGE_PIN E20 [get_ports {J5[10]}] #IO B35 IN21
set_property PACKAGE_PIN E19 [get_ports {J5[11]}] #IO B35 LP21
set_property PACKAGE_PIN D22 [get_ports {J5[12]}] #IO B35 LP16
set_property PACKAGE_PIN C22 [get_ports {J5[13]}] #IO B35 LN16
set_property PACKAGE_PIN B22 [get_ports {J5[14]}] #IO B35 LN18
set_property PACKAGE_PIN B21 [get_ports {J5[15]}] #IO B35 LP18
set_property PACKAGE_PIN B17 [get_ports {J5[16]}] #IO B35 LNS
set_property PACKAGE_PIN B16 [get_ports {J5[17]}] #IO B35 LP8
set_property PACKAGE_PIN A17 [get_ports {J5[18]}] #IO B35 LN9
set_property PACKAGE_PIN A16 [get_ports {J5[19]}] #IO B35 LP9
set_property PACKAGE_PIN D20 [get_ports {J5[20]}] #IO B35 LP14
set_property PACKAGE_PIN C20 [get_ports {J5[21]}] #IO B35 LN14
set_property PACKAGE_PIN B15 [get_ports {J5[22]}] #IO B35 LN7
set_property PACKAGE_PIN C15 [get_ports {J5[23]}] #IO B35 LP7
set_property PACKAGE_PIN D17 [get_ports {J5[24]}] #IO B35 LN2
set_property PACKAGE_PIN D16 [get_ports {J5[25]}] #IO B35 LP2
set_property PACKAGE_PIN D15 [get_ports {J5[26]}] #IO B35 LN3
set_property PACKAGE_PIN E15 [get_ports {J5[27]}] #IO B35 LP3
set_property PACKAGE_PIN D18 [get_ports {J5[28]}] #IO B35 LP12
set_property PACKAGE_PIN C19 [get_ports {J5[29]}] #IO B35 LN12
set_property PACKAGE_PIN E16 [get_ports {J5[30]}] #IO B35 LN1
set_property PACKAGE_PIN F16 [get_ports {J5[31]}] #IO B35 LP1
set_property PACKAGE_PIN G15 [get_ports {J5[32]}] #IO B35 LP4
set_property PACKAGE_PIN G16 [get_ports {J5[33]}] #IO B35 LN4

## J6 on board (BANK33 VADJ)
# Set voltage level for banks 33 (match with jumper setting on board)
set_property IOSTANDARD LVCMOS33 [get_ports {J6[*]}]
set_property PACKAGE_PIN U22 [get_ports {J6[0]}] #J6/1 = IO B33 LN2
set_property PACKAGE_PIN T22 [get_ports {J6[1]}] #J6/2 = IO B33 LP2
set_property PACKAGE_PIN W22 [get_ports {J6[2]}] #J6/3 = IO B33 LN3
set_property PACKAGE_PIN V22 [get_ports {J6[3]}] #J6/4 = IO B33 LP3
set_property PACKAGE_PIN Y21 [get_ports {J6[4]}] #J6/5 = IO B33 LN9
set_property PACKAGE_PIN Y20 [get_ports {J6[5]}] #J6/6 = IO B33 LN9
set_property PACKAGE_PIN AB22 [get_ports {J6[6]}] #J6/7 = IO B33 LP7
set_property PACKAGE_PIN AB21 [get_ports {J6[7]}] #J6/8 = IO B33 LP7
set_property PACKAGE_PIN AB21 [get_ports {J6[8]}] #J6/9 = IO B33 LN8
set_property PACKAGE_PIN AA21 [get_ports {J6[9]}] #J6/10 = IO B33 LP8
set_property PACKAGE_PIN AB19 [get_ports {J6[10]}] #J6/11 = IO B33 LP10
set_property PACKAGE_PIN AB20 [get_ports {J6[11]}] #J6/12 = IO B33 LN10
set_property PACKAGE_PIN AA19 [get_ports {J6[12]}] #J6/13 = IO B33 LN11
set_property PACKAGE_PIN Y19 [get_ports {J6[13]}] #J6/14 = IO B33 LP11
set_property PACKAGE_PIN AB16 [get_ports {J6[14]}] #J6/15 = IO B33 LN18
set_property PACKAGE_PIN AA16 [get_ports {J6[15]}] #J6/16 = IO B33 LP18
set_property PACKAGE_PIN Y18 [get_ports {J6[16]}] #J6/17 = IO B33 LP12
set_property PACKAGE_PIN AA18 [get_ports {J6[17]}] #J6/18 = IO B33 LN12
set_property PACKAGE_PIN AB14 [get_ports {J6[18]}] #J6/19 = IO B33 LP24
set_property PACKAGE_PIN AB15 [get_ports {J6[19]}] #J6/20 = IO B33 LN24
set_property PACKAGE_PIN Y13 [get_ports {J6[20]}] #J6/21 = IO B33 LP23
set_property PACKAGE_PIN AA13 [get_ports {J6[21]}] #J6/22 = IO B33 LN23
set_property PACKAGE_PIN W13 [get_ports {J6[22]}] #J6/23 = IO B33 LP20
set_property PACKAGE_PIN W13 [get_ports {J6[23]}] #J6/24 = IO B33 LN20
set_property PACKAGE_PIN W18 [get_ports {J6[24]}] #J6/25 = IO B33 LN13
set_property PACKAGE_PIN W17 [get_ports {J6[25]}] #J6/26 = IO B33 LP13
set_property PACKAGE_PIN AA17 [get_ports {J6[26]}] #J6/27 = IO B33 LP17
set_property PACKAGE_PIN AB17 [get_ports {J6[27]}] #J6/28 = IO B33 LN17
set_property PACKAGE_PIN W16 [get_ports {J6[28]}] #J6/29 = IO B33 LP14
set_property PACKAGE_PIN Y16 [get_ports {J6[29]}] #J6/30 = IO B33 LN14
set_property PACKAGE_PIN Y14 [get_ports {J6[30]}] #J6/31 = IO B33 LP22
set_property PACKAGE_PIN AA14 [get_ports {J6[31]}] #J6/32 = IO B33 LN22
set_property PACKAGE_PIN W15 [get_ports {J6[32]}] #J6/33 = IO B33 LN19
set_property PACKAGE_PIN Y14 [get_ports {J6[33]}] #J6/34 = IO B33 LP19

```

```

# VER V1.0 / V1.1 V1.0/V1.1/V1.2
# HDMI (DVI) outputs
set_property PACKAGE_PIN J21 [get_ports {hdmi_d_p[2]}]
set_property PACKAGE_PIN L21 [get_ports {hdmi_d_p[1]}]
set_property PACKAGE_PIN W21 [get_ports {hdmi_d_p[0]}]
set_property PACKAGE_PIN N22 [get_ports {hdmi_clk_p}]

# VER V1.3 / V1.3B V1.3/V1.3B
# HDMI (DVI) outputs
set_property PACKAGE_PIN J21 [get_ports {hdmi_d_p[2]}]
set_property PACKAGE_PIN L21 [get_ports {hdmi_d_p[1]}]
set_property PACKAGE_PIN W21 [get_ports {hdmi_d_p[0]}]
set_property PACKAGE_PIN N19 [get_ports {hdmi_clk_p}]
set_property -dict {PACKAGE_PIN K20 IOSTANDARD LVCMOS33} [get_ports HDMI_SDA]
set_property -dict {PACKAGE_PIN L19 IOSTANDARD LVCMOS33} [get_ports HDMI_SCL]
set_property -dict {PACKAGE_PIN L19 IOSTANDARD LVCMOS33} [get_ports HDMI_RX_HPD]

```

HELLOFPGA.COM

```

## ===== R =====
set_property -dict {PACKAGE_PIN Y4 IOSTANDARD LVCMOS33} [get_ports {RGB_LCD_R[7]}]
set_property -dict {PACKAGE_PIN V10 IOSTANDARD LVCMOS33} [get_ports {RGB_LCD_R[6]}]
set_property -dict {PACKAGE_PIN AB12 IOSTANDARD LVCMOS33} [get_ports {RGB_LCD_R[5]}]
set_property -dict {PACKAGE_PIN U10 IOSTANDARD LVCMOS33} [get_ports {RGB_LCD_R[4]}]
set_property -dict {PACKAGE_PIN AA8 IOSTANDARD LVCMOS33} [get_ports {RGB_LCD_R[3]}]
set_property -dict {PACKAGE_PIN AB7 IOSTANDARD LVCMOS33} [get_ports {RGB_LCD_R[2]}]
set_property -dict {PACKAGE_PIN AA12 IOSTANDARD LVCMOS33} [get_ports {RGB_LCD_R[1]}]
set_property -dict {PACKAGE_PIN V7 IOSTANDARD LVCMOS33} [get_ports {RGB_LCD_R[0]}]
## ===== G =====
set_property -dict {PACKAGE_PIN AB10 IOSTANDARD LVCMOS33} [get_ports {RGB_LCD_G[7]}]
set_property -dict {PACKAGE_PIN AA9 IOSTANDARD LVCMOS33} [get_ports {RGB_LCD_G[6]}]
set_property -dict {PACKAGE_PIN Y9 IOSTANDARD LVCMOS33} [get_ports {RGB_LCD_G[5]}]
set_property -dict {PACKAGE_PIN W8 IOSTANDARD LVCMOS33} [get_ports {RGB_LCD_G[4]}]
set_property -dict {PACKAGE_PIN Y9 IOSTANDARD LVCMOS33} [get_ports {RGB_LCD_G[3]}]
set_property -dict {PACKAGE_PIN V6 IOSTANDARD LVCMOS33} [get_ports {RGB_LCD_G[2]}]
set_property -dict {PACKAGE_PIN V8 IOSTANDARD LVCMOS33} [get_ports {RGB_LCD_G[1]}]
set_property -dict {PACKAGE_PIN AB9 IOSTANDARD LVCMOS33} [get_ports {RGB_LCD_G[0]}]
## ===== B =====
set_property -dict {PACKAGE_PIN W6 IOSTANDARD LVCMOS33} [get_ports {RGB_LCD_B[7]}]
set_property -dict {PACKAGE_PIN AB5 IOSTANDARD LVCMOS33} [get_ports {RGB_LCD_B[6]}]
set_property -dict {PACKAGE_PIN AB4 IOSTANDARD LVCMOS33} [get_ports {RGB_LCD_B[5]}]
set_property -dict {PACKAGE_PIN AB6 IOSTANDARD LVCMOS33} [get_ports {RGB_LCD_B[4]}]
set_property -dict {PACKAGE_PIN W7 IOSTANDARD LVCMOS33} [get_ports {RGB_LCD_B[3]}]
set_property -dict {PACKAGE_PIN AA7 IOSTANDARD LVCMOS33} [get_ports {RGB_LCD_B[2]}]
set_property -dict {PACKAGE_PIN VA4 IOSTANDARD LVCMOS33} [get_ports {RGB_LCD_B[1]}]
set_property -dict {PACKAGE_PIN Y5 IOSTANDARD LVCMOS33} [get_ports {RGB_LCD_B[0]}]
## ===== CONTROL =====
set_property -dict {PACKAGE_PIN V9 IOSTANDARD LVCMOS33} [get_ports {RGB_LCD_HSYNC}]
set_property -dict {PACKAGE_PIN AB2 IOSTANDARD LVCMOS33} [get_ports {RGB_LCD_VSYNC}]
set_property -dict {PACKAGE_PIN AA4 IOSTANDARD LVCMOS33} [get_ports {RGB_LCD_CLK}]
set_property -dict {PACKAGE_PIN AA6 IOSTANDARD LVCMOS33} [get_ports {RGB_LCD_DE}]
## ===== BACKLIGHT =====
set_property -dict {PACKAGE_PIN U7 IOSTANDARD LVCMOS33} [get_ports {RGB_LCD_BL}]
## ===== RST RESERVE =====
set_property -dict {PACKAGE_PIN W5 IOSTANDARD LVCMOS33} [get_ports {RGB_LCD_RST}]
## ===== TOUCH (I2C) =====
set_property -dict {PACKAGE_PIN U6 IOSTANDARD LVCMOS33} [get_ports {RGB_LCD_TP_RES}]
set_property -dict {PACKAGE_PIN U4 IOSTANDARD LVCMOS33} [get_ports {RGB_LCD_TP_INT}]
set_property -dict {PACKAGE_PIN U5 IOSTANDARD LVCMOS33} [get_ports {RGB_LCD_TP_SCL}]
set_property -dict {PACKAGE_PIN AB1 IOSTANDARD LVCMOS33} [get_ports {RGB_LCD_TP_SDA}]

```

**RGB LCD FPC CONNECTOR**  
ONLY FOR V1.3B

Title			
HELLOFPGA.COM			
Size	Document Number	Rev	
B	<Doc>	<1.3B>	
Date:	Tuesday, April 14, 2026	Sheet	1 of 1